

OCTAVE

HP 700

FOREWORD

Congratulations and thank you for choosing the OCTAVE tube preamplifier

HP 700

You are about to enjoy the benefits of one of the world's most innovative and reliable preamplifiers, the **HP 700**. Take care of it, and your preamplifier will provide you with many years of listening pleasure.

You often hear people claim that there has been no real progress in tube amplifier design for years. The operating principles of tubes have been documented extensively and are well known to amplifier designers. The same can, of course, be said for transistor amplifiers.

Nevertheless, there is still room for further development with both of these technologies. This is both necessary and desirable. With tube amplifiers in particular, a general reluctance to depart from the classic circuit designs has not done the technology any favors. Today's loudspeakers and source equipment provide better performance than ever before, but also make greater demands on amplifiers. Modern sound reproduction equipment delivers a level of performance at a price that simply would not have been possible 20 or even 10 years ago.

These advances have been achieved through the application of cutting-edge technology as it becomes available and affordable.

Integrating these technologies into amplifier design demands a detailed knowledge of the inner workings of amplifiers and an appreciation of the sonic ramifications of each modification.

We have specialized in tube amplification for the past 30 years, during which time we have developed a number of innovative technologies that have earned us a reputation as one of the leaders in the field.

We hope you will enjoy many hours of wonderful music with your OCTAVE preamplifier.



Andreas Hofmann

CONTENTS

1. OCTAVE TECHNOLOGY	5
1.1. OCTAVE amps in contrast to other tube amplifiers.....	5
1.2. Description HP 700.....	6
2. SAFETY INSTRUCTIONS.....	7
2.1. Before you begin.....	7
2.1.1. In case of emergency: disconnect the plug from the mains supply	7
2.1.2. Do not open the case	7
2.1.3. Service and maintenance.....	7
2.1.4. Symbols and terms used in warnings.....	7
2.1.5. Before connecting.....	8
2.1.6. Grounding.....	8
2.2. Placement.....	8
2.2.1. Location	8
2.2.2. Cover	8
2.2.3. Ventilation.....	8
2.3. Warranty	8
3. SETTING UP	9
3.1. Checking the delivery contents.....	9
3.2. Connecting the amplifier	9
3.3. Running in.....	9
4. OPERATION	10
4.1. HP 700 front panel.....	10
5. CONNECTIONS	11
5.1. HP 700 rear panel.....	11
6. EXTERNAL POWER SUPPLY	13
6.1. Front of power supply	13
6.2. Rear of power supply.....	13
7. MULTI-CHANNEL MODE	14
7.1. The HP 700 in multi-channel mode	14
8. REMOTE CONTROL FOR VOLUME	16
8.1. Remote control operating elements.....	16
8.2. Battery replacement.....	16

CONTENTS

9. TUBES	17
9.1. Line tube layout with adjustment capability	17
9.2. Phono tube layout.....	18
9.3. Control unit tube layout.....	19
9.4. Replacing tubes	20
9.5. Tube service life.....	20
10. OUTPUT RESISTANCE	21
10.1. Adjusting the output resistance	21
11. OPTIONS	22
11.1. Option: Additional line-level input module	22
11.1.1. Assembling the additional line-level input module	22
11.1.2. Available line-level input modules: see inlay manual “In- and Output Modules” 23	
11.2. Option HP 700 with phono.....	24
11.2.1. HP 700 with phono RIAA	24
11.2.2. Subsonic filter.....	25
11.2.3. Assembling the phono input modules	26
11.2.4. Available phono input modules: see inlay manual “In- and Output Modules”.....	26
11.3. Option: HP 700 with control unit.....	27
11.4. Option: HP 700 with stepped attenuator.....	29
12. TROUBLESHOOTING	30
12.1. Troubleshooting	30
13. TECHNICAL DATA	31
13.1. In- and outputs.....	31
13.2. Dimensions	33
13.2.1. HP 700 preamplifier (dimensions in mm).....	33
13.2.2. External power supply (dimensions in mm).....	33
13.3. Diagrams	34
13.3.1. HP 700 line frequency response.....	34
13.3.2. FFT interference spectrum.....	34
13.3.3. Control range and balance control frequency response	35
13.3.4. Line stage hum and noise level	35

OCTAVE TECHNOLOGY
OCTAVE amps in contrast to other tube amplifiers

1. OCTAVE TECHNOLOGY

1.1. OCTAVE amps in contrast to other tube amplifiers

Sound	The design goal of OCTAVE amplifiers is honest, natural sound reproduction. The sound characteristics of an amplifier are derived from the sum of all its parts. Tubes themselves do not guarantee high quality sound.
Amplifier design	The frequency range and output resistant limitations of classic tube designs are evident as soon as you connect the amplifiers. These designs often only perform to their full potential when they are used with special cables and power amplifiers. OCTAVE amplification and power supply technology has largely overcome these well-known problems. Thanks to their unique output stage design, they will maintain their optimum sound quality with virtually any power amplifier, irrespective of the cables.
Control + monitoring	OCTAVE employs the latest electronic circuit designs to create the best possible operating conditions for the tubes, and thus for the amplifier itself.

OCTAVE tube technology

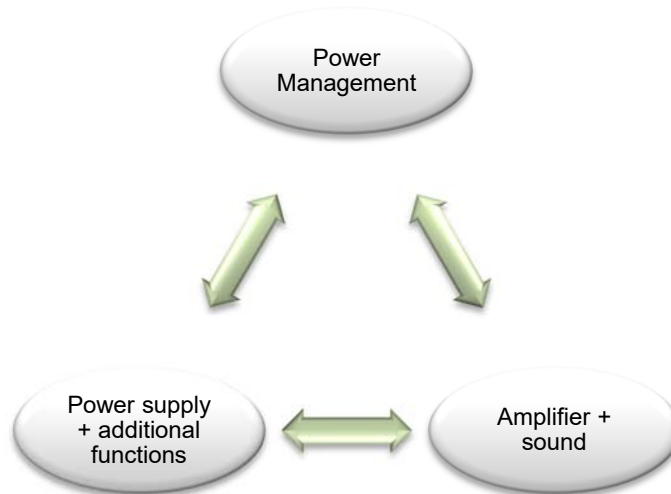

OCTAVE amplifiers are equipped with a proprietary control and monitoring system we call **Power Management**. This is an “electronic brain” within the amp that regulates and controls all of the amplifier’s functions. It includes the **Soft Start Electronics** that gently ramp up the heating and supply voltages to minimize wear and tear on the components. In the event of a problem, the Power Management’s **protection system** disconnects the unit from the power supply. Power Management helps us to achieve a completely consistent sound while at the same time ensuring the total reliability of our products.

Hand built OCTAVE amplifiers are hand built and individually tested. They are designed and developed by Andreas Hofmann. The company has its own winding department, in which all transformers are especially custom-wound for each amplifier.

Made in Germany OCTAVE amplifiers are 100% built in Germany. Our employees are highly qualified and committed. We collaborate closely with local specialist subcontracting companies. The hardware components are all manufactured on modern CNC machines.

OCTAVE TECHNOLOGY

Description HP 700

1.2. Description HP 700

The **HP 700** is a member of a new generation of tube amplifiers built by OCTAVE. The first model of this line was the **Jubilee** reference preamplifier, followed by the **HP 500 SE** and **HP 300 SE** preamplifiers. This new development is based on a newly developed power supply with precise, low-noise voltage control circuits. The newly developed amplifiers are extremely low-noise and low-distortion. In conjunction with the exceptionally low output resistance, virtually every output stage can be achieved with any signal cables for the first time ever with a tube preamplifier. Furthermore, the HP700 is **manufactured perfectly**, as goes without saying for all OCTAVE amplifiers. The solid connecting sockets allow the connection of high-quality NF wires with large plugs. As with all OCTAVE amplifiers, the **HP 700** is equipped with a **real power switch**. Every OCTAVE product is built **in Germany in single-piece production** and is subject to a 100% check. A 48-hour endurance run completes the final inspection. **Transformers** are **individually designed and produced** for each model in our own house.

Special characteristics of the HP 700

Once again, OCTAVE is the pioneer with innovative equipment features.

- **It is equipped with an external power supply**, while the internal supply voltages feature complex electronic regulation, ensuring a consistent sound even with a highly fluctuating power supply. In addition, the built-in control logic guarantees top reliability and achieves a theoretical maximum service life of the tubes (up to approximately 50,000 h) thanks to soft-start techniques.
- An additional function of the power supply is a **protective circuit**, which releases the output of the **HP 700** via a relay with a time delay or disconnects it immediately in case of a malfunction. Click interferences caused by a loss of power supply, etc. are therefore ruled out completely.
- The **multichannel bypass function** makes the **HP 700** one of the most versatile preamps in this range (see chapter 7, page 14). An RCA or XLR input can be selected for the bypass function. This set-up in the **HP 700** is achieved through logic-controlled input selection. The switching elements are high-quality industrial-grade gold contact relays.
- The **HP 700** features **two XLR inputs**, one of which can also be used for the bypass function.
- **Three-stage gain adjustment**. This feature allows for the optimal adjustment of the overall gain to the efficiency of the loudspeaker or the input sensitivity of the power amplifier. This achieves an optimum volume level and allows for sensitive volume control.
- **Adjusting the output resistance of the line stage**. The output resistance can be set between 100 and 300 ohms in two settings. This allows the sound of the preamplifier to be adjusted optimally to the signal cable used and to the input impedance of the power amplifier.
- **XLR outputs with special balanced transformers** as in studio technology. Galvanically isolated transformer-balanced XLR outputs are unrivaled in terms of sound quality and prevent humming due to earth loops.
- A further feature is the **monitor output**. An A/D converter for a PC or a classic tape can be connected here.
- **Arbitrary inputs through module technology (option)**. Up to two input modules (line and phono) can be used simultaneously. This ensures the optimum input for every configuration. The modules can be retrofitted at any time.
- **Advanced adjustment functions with the control unit option**. The control unit includes a tone control in tube technology, two precise level controls for exact balance correction, and a switching apparatus to select an output (three outputs in total).

SAFETY INSTRUCTIONS

Before you begin

2. SAFETY INSTRUCTIONS

2.1. Before you begin

2.1.1. In case of emergency: disconnect the plug from the mains supply

Never use an amplifier that is damaged or faulty. Make sure it has been labeled as defective and that it cannot be used until it has been repaired by a qualified service engineer. Make sure that there is easy access to the IEC socket and power cable.

2.1.2. Do not open the case



There are dangerously high voltages and hot tubes inside this equipment. To avoid a burn or the risk of electric shock, never allow anyone except qualified personnel to open the case or remove the grill.

2.1.3. Service and maintenance

For reasons of safety, please ensure that servicing, repairs and other modifications to OCTAVE equipment are carried out only by a qualified technician. Defective fuses should also only be replaced by a qualified technician. Always replace fuses with ones of the same type and rating. If your amplifier requires servicing, please ship or take your equipment directly to OCTAVE or to one of our authorized service centers.

2.1.4. Symbols and terms used in warnings

The following warnings, symbols and terms are used in this document in compliance with the American National Standard ANSI Z535.6-2011:

	The general danger symbol, in conjunction with the terms CAUTION , WARNING , or DANGER , warns of the risk of severe injury.
	The triangle symbol with the lightning bolt warns of non-isolated, dangerous voltages inside the case and of hazards posed by electrical shocks. Follow all subsequent instructions to avoid injury or death.
ATTENTION	Indicates a danger that could lead to damage or destruction of the device.
CAUTION	Indicates a danger that represents a low or medium risk of injury.
WARNING	Indicates a danger that could lead to death or severe injury.
DANGER	Indicates a danger that will result in death or severe injury.

Warning format

⚠ WARNING TERM
Type and source of danger
Consequences of ignoring the warning
▶ Action needed to avoid danger

SAFETY INSTRUCTIONS

Placement

2.1.5. Before connecting

Make sure that the voltage of your amplifier matches your local supply voltage.

2.1.6. Grounding

This amplifier is a protection class 2 device (without an earth conductor), while the power supply is class 1. As a result, a three-pin power cable with a protective ground contact must be used (included in the scope of delivery).

2.2. Placement

2.2.1. Location

- OCTAVE equipment is designed strictly for use in a dry domestic environment. Do not use it in open air or in damp environments!
- Never place plants or liquid-filled containers on your amplifier. Take care that objects do not fall or liquids are not spilled into the enclosure. Should this happen, disconnect the mains plug immediately and have your amplifier checked by a qualified service technician.
- Condensation may form if the amplifier is taken from a cold environment into a warm one. In this case, wait until the amplifier has reached room temperature and is dry before switching it on.
- Avoid installing the amplifier close to sources of heat, such as heaters, or anywhere that it may be in direct sunlight.
- Do not operate your OCTAVE amplifier near flammable materials, gases, or vapors. Avoid areas where there may be heavy accumulations of dust or where the amplifier may be subject to mechanical vibration.
- Place your OCTAVE amplifier on a stable, even surface.

2.2.2. Cover

Never operate the amplifier without the cover.

2.2.3. Ventilation

- Ensure sufficient air circulation around your amplifier. If you intend to install your equipment in a cupboard or a shelf unit, ensure that there is at least a 10 centimeter gap between the ventilation slots and the walls all around the amplifier.
- To prevent heat accumulation, the back of the cupboard should have ventilation holes.
- Do not rest the equipment on a soft surface such as carpet or foam sheeting.

2.3. Warranty

OCTAVE can only guarantee the safety, reliability and performance of this unit if modifications and repairs are carried out by specialized personnel and if the amplifier is operated in accordance with the instructions contained in this manual.

SETTING UP

Checking the delivery contents

3. SETTING UP

3.1. Checking the delivery contents

Scope of delivery

- HP 700
- External power supply
- Power cable
- Remote control
- TX10 pin wrench to open the cover
- Manual with warranty card

3.2. Connecting the amplifier

1. In your own interest, please observe the safety instructions and positioning information (see chapter 2, page 7)
2. Before connecting your OCTAVE amplifier, switch off all other equipment that you intend to connect to it. This will avoid a source of possible malfunctions when you plug these components in.
3. Connect the inputs from your power amplifier to the appropriate outputs on the **HP 700**.
4. Connect your loudspeakers to your power amplifier, making sure that you observe the correct polarity (positive on the amplifier to positive on the speakers).
5. Check that the amplifier is switched off before connecting the power cable to the wall socket.
6. Check that the volume control is not set at maximum before playing music through the preamplifier and that the function switch (1) is set to the setting Gain Low, Med, or High.
7. Switch on the **HP 700** using the power switch on the power supply. (See chapter 4, page 10)

Power switch

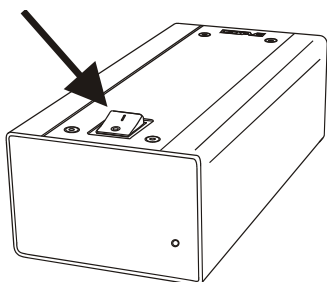

Note

The preamplifier requires approximately 2 minutes to warm up. During this warm-up period, the outputs are shorted to ground to avoid disturbances.

Do not switch the function switch during the warm-up phase, as this unnecessarily extends the start-up procedure.

8. Switch on the other components in any order.

3.3. Running in

All OCTAVE equipment is subject to a 48-hour endurance run to burn in the tubes. The tubes are preselected for use in each particular model. **The sound quality of tube equipment improves throughout the initial running-in period of up to three months.**

OPERATION HP 700 front panel

4. OPERATION

4.1. HP 700 front panel

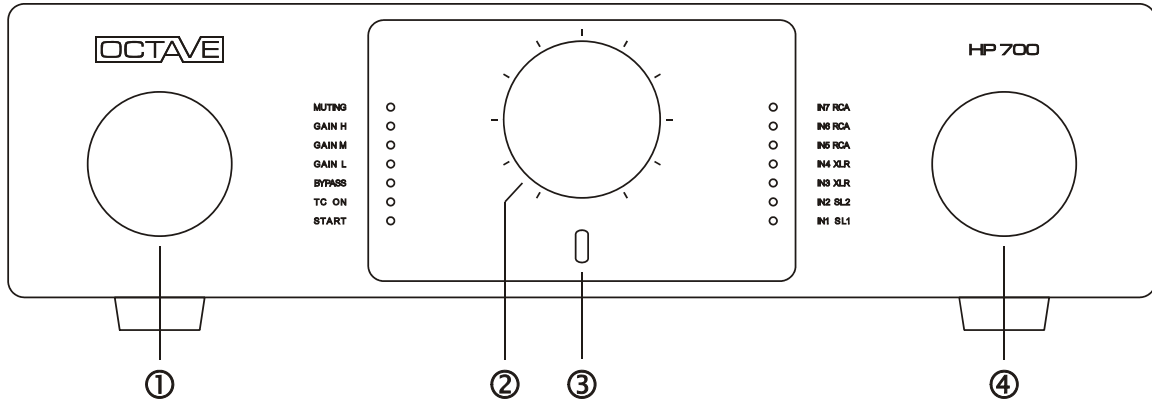

Legend

(1) Mode switch (function switch)	The muting, line stage gain, home theater bypass multi-channel function, and tone control are activated here.	
Muting	The muting LED illuminates when muting is on and during the start-up phase. In this setting, the preamplifier outputs are short-circuited and music cannot be played. This switch position should be activated while connecting source devices to the HP 700.	
Gain Low, Med, and High	The gain setting can be selected according to the efficiency of the other components. When you change the position of the switch, the muting function is activated for 20 seconds to prevent switching malfunctions.	
Bypass HT	In this setting, the gain of the line stage is 1 and the volume control is bypassed. This setting is intended for multi-channel applications with volume control on the multi-channel receiver. The bypass HT RCA input is separate; the bypass function can be switched to an XLR input.	
TC On	This LED illuminates if the tone control is on (only available for control unit option, see section 11.3, page 27)	
Start	This LED only illuminates during the two-minute start-up phase. During this period, the muting LED also illuminates.	
(2) Volume control	(Also optionally available as a step switch, see section 11.4)	
(3) IR sensor	To ensure the correct function of the remote control, make sure that the infrared sensor is not covered.	
(4) Input selector switch	For input selection. The selected input is indicated with an LED.	
IN1-SL1, IN2-SL2	Input module 1 Input module 2	The signal LEDs for IN1 and IN2 only illuminate if a module is installed!
IN3-XLR, IN4-XLR	XLR input for line-level sources	
IN5-RCA, IN6-RCA, IN7-RCA	RCA input for line-level sources	

CONNECTIONS
HP 700 rear panel

5. CONNECTIONS

5.1. HP 700 rear panel

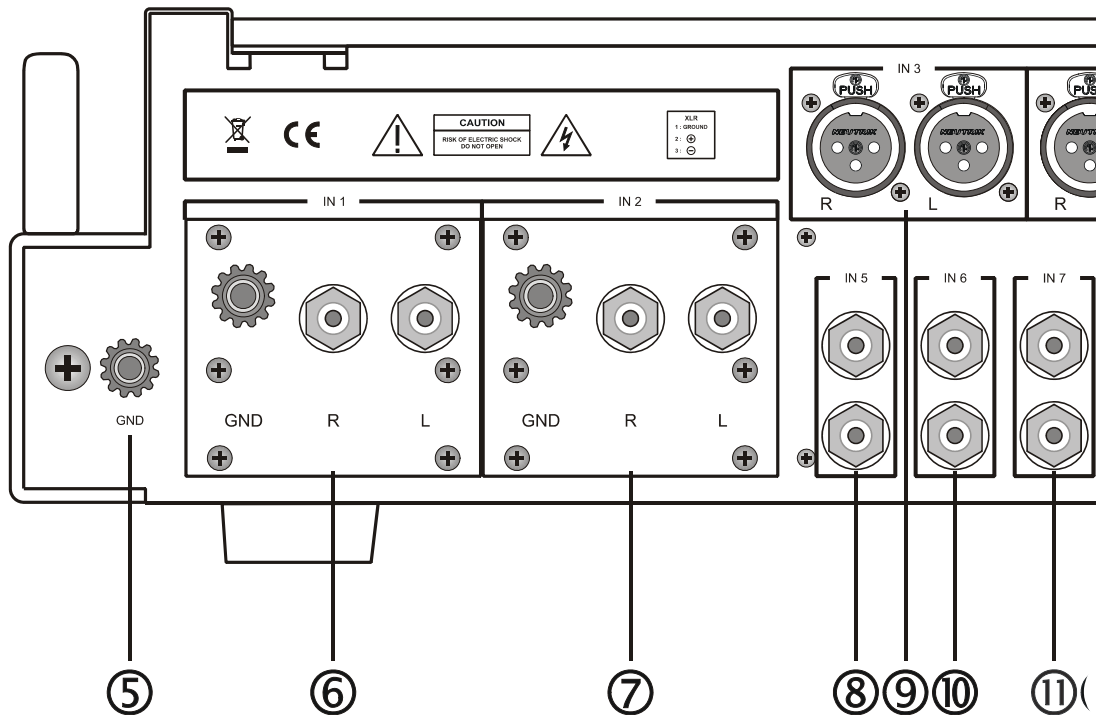

Legend

(5)	GND connection	Ground connection for phono
(6)	IN 1 SL1	Slot for a phono or line input module
(7)	IN 2 SL2	Slot for a phono or line input module
(8)	IN 5 RCA input	Line-level input for CD, tuner, etc.
(9)	IN 3 XLR input	Balanced line-level input for CD, DAC, etc.
(10)	IN 6 RCA input	Line-level input for CD, tuner, etc.
(11)	IN 7 RCA input	Line-level input for CD, tuner, etc.

Note On the connector panel, the bottom row of sockets (red) is the right channel, while the top row of sockets (white) is the left channel.

CONNECTIONS
HP 700 rear panel

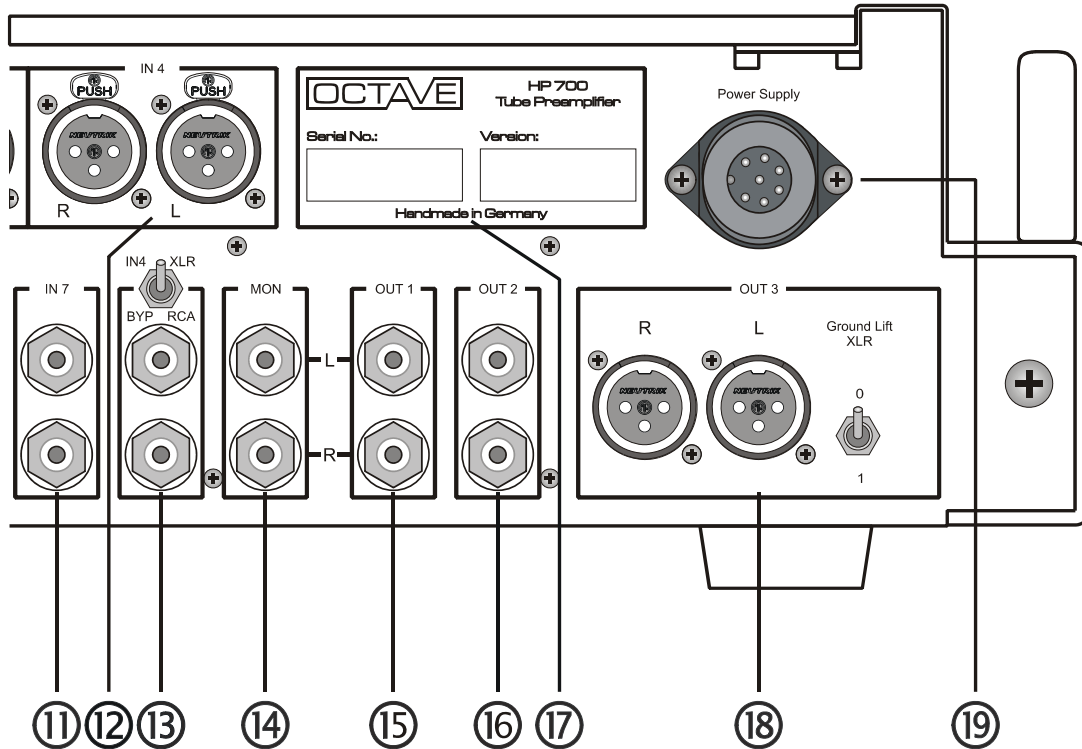

Legend

(12)	IN 4 XLR input	Balanced line-level input for CD, DAC, in bypass setting, can be used as alternative home theater input.
(13)	RCA bypass	Home theater input for multi-channel receiver
(14)	Monitor outputs	Unregulated outputs for recording equipment, computers, etc.
(15)	OUT 1	RCA outputs for power amplifiers
(16)	OUT 2	RCA outputs for power amplifiers
(17)	Name plate	With serial number and version
(18)	OUT 3	XLR output for balanced power amplifiers. 1 = ground, 2 = positive, 3 = negative ground lift XLR. With the ground lift, the XLR outputs can be isolated from the signal ground for the preamplifier. Setting 0 corresponds to the ground isolation. In setting 1, the ground of the XLR outputs over 3.3 ohms is connected to the preamplifier ground. Isolating the ground is useful when multiple devices in the system have a power supply with a three-pin grounding plug to prevent ground loops.
(19)	Connection for the external power supply	

EXTERNAL POWER SUPPLY Front of power supply

6. EXTERNAL POWER SUPPLY

The HP 700 is switched on and off using a switch on the power supply.

6.1. Front of power supply

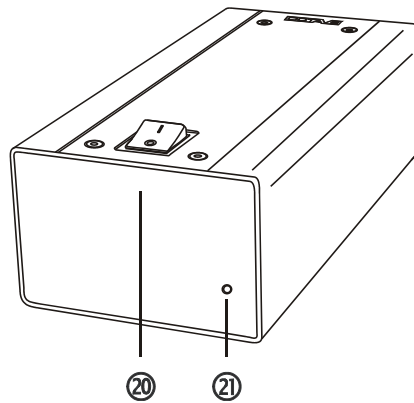

Legend

(20)	Power (switch) power supply	The LED on the power supply illuminates when the power supply is on. During the start-up phase, the start and muting LEDs illuminate on the pre-amplifier. After the start-up phase, the start and muting LEDs go out; if the mode switch is not set to the muting setting, the device is ready to play music.
(21)	Control light	Power on/off

6.2. Rear of power supply

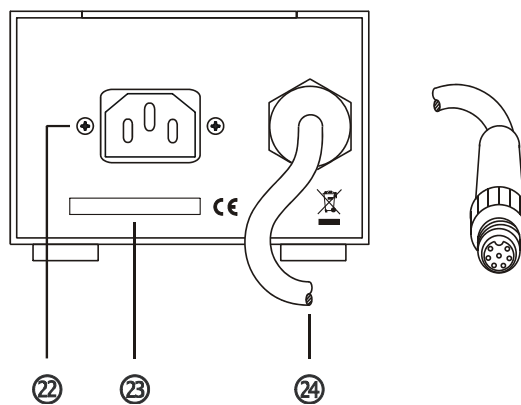

Legend

(22)	Power input, IEC socket
(23)	Serial no. and supply voltage
(24)	HP 700 connecting cable

MULTI-CHANNEL MODE

The HP 700 in multi-channel mode

7. MULTI-CHANNEL MODE

7.1. The HP 700 in multi-channel mode

Many customers want to use their multi-channel system for a TV, DVD recorder, etc. without giving up the sound of a high-end stereo system to listen to their music. In such cases, these customers either set up two separate systems (e.g. doubled power amplifiers, doubled speakers, etc.) or have to fiddle with plugs every time they want to hear multi-channel and classic stereo.

The HP 700 is the solution to this problem.

With the **HP 700**, it is possible to use the two-channel amplifier/speaker combination as part of the multi-channel system. This eliminates any double volume control issues. Normally, the two-channel combination for front right and left is used since these are the main channels in the multi-channel system. (5 + 1, 3 + 1 systems)

For this reason, both the front channels (right and left) on the multi-channel source are connected to the bypass input (13) on the **HP 700** if the multi-channel device only has RCA outputs. If the multi-channel receiver also has balanced outputs for the two main channels, the bypass multi-channel input on the **HP 700** can be switched to the balanced input IN 4 (12).

The signals “front left” and “front right” on the multi-channel source device are “connected through” with the function switch on the front (1) (Bypass HT setting) and are available directly for the two-channel power amplifier at the RCA outputs or (balanced) XLR outputs. In the “Bypass” setting, the “Bypass” LED illuminates; the “Gain med” LED, and the “IN 4” illuminate if the bypass input selector switch is set to “IN 4 XLR”. In this mode, the volume for these outputs must be set on the multi-channel source device.

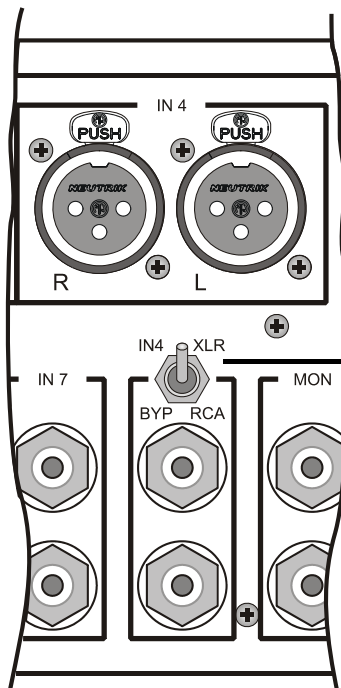

Selector switch for multi-channel input/RCA-XLR

This switch determines the input for the multi-channel/home theater function.

Toggle switch up: *IN 4 XLR is the multi-channel input.*

Toggle switch down: *Bypass RCA is the multi-channel input.*

MULTI-CHANNEL MODE
The HP 700 in multi-channel mode

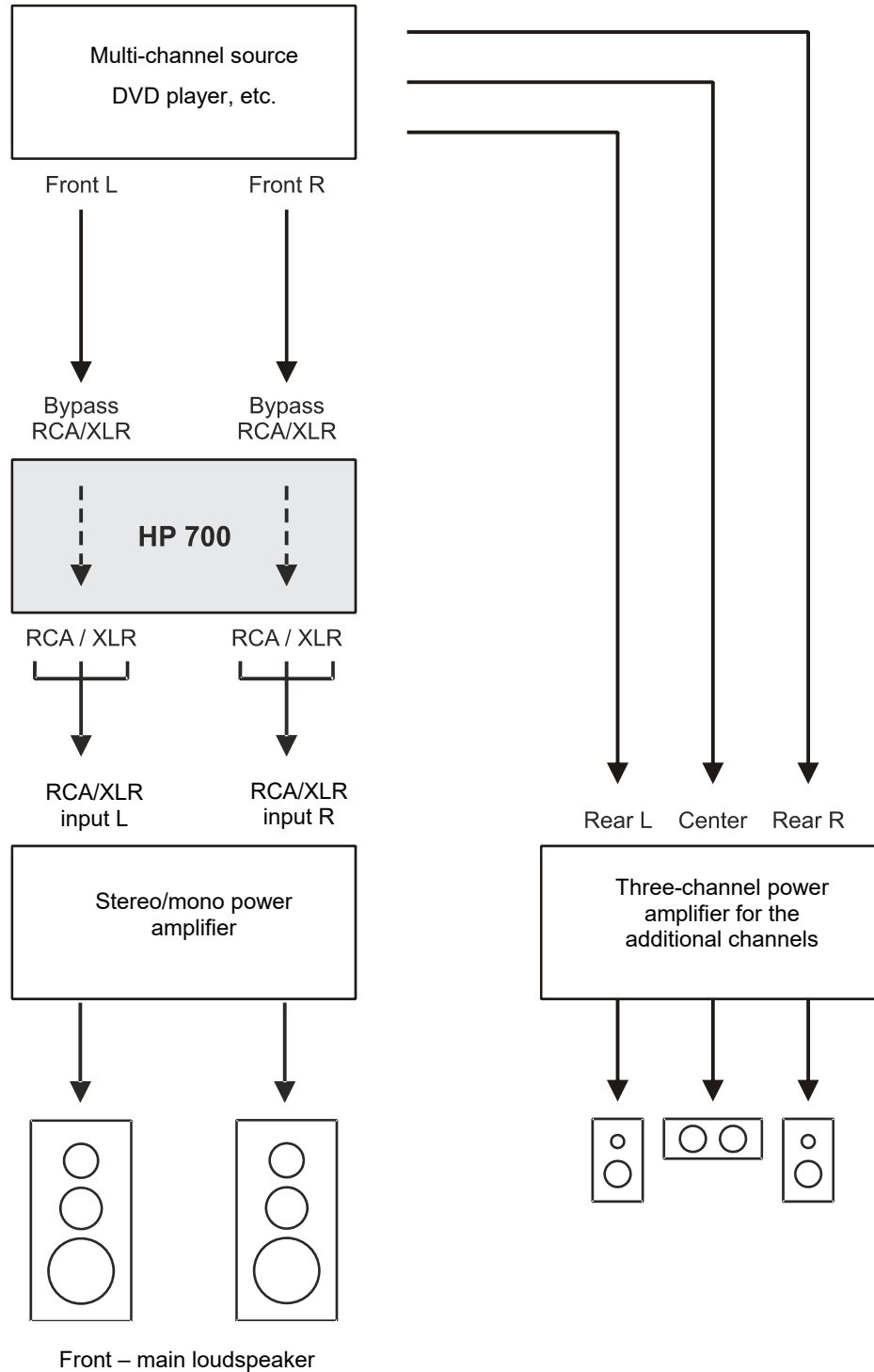

In multi-channel mode, i.e. in the “bypass” setting, the common volume of the multi-channel system has to be set on the multi-channel source. For the RCA outputs and the balanced XLR output, the volume control for the **HP 700** is then disabled. In this mode, the amplification factor of the **HP 700** is 0 dB for RCA and XLR.

REMOTE CONTROL FOR VOLUME

Remote control operating elements

8. REMOTE CONTROL FOR VOLUME

8.1. Remote control operating elements

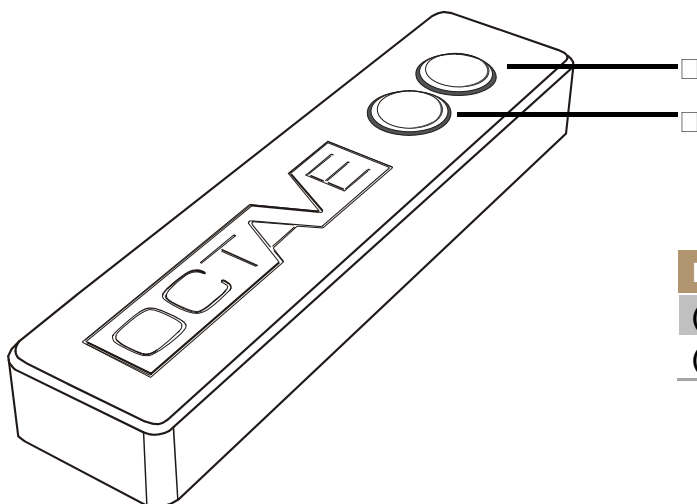

Legend

- | | |
|-----|-------------|
| (1) | Volume up |
| (2) | Volume down |

8.2. Battery replacement

1. Use a "Philips 1" screwdriver to disassemble the base plate.
2. Remove the batteries.
3. Insert two new AAA 1.5 V batteries.

Tip **Make sure not to press the buttons while inserting the batteries!**

If the remote control does not work after the batteries are replaced, remove the new batteries and wait at least **2 hours**.

You can then re-insert the batteries and the remote control should work.

4. Replace the base plate taking care not to tighten the screws too much.

Note

After use, the batteries we have supplied for the remote control can be returned to the point of sale free of charge. Please do not throw them in the garbage.



You cannot control the volume with the remote control in case of the option stepped attenuator.

TUBES

Line tube layout with adjustment capability

9. TUBES

9.1. Line tube layout with adjustment capability

⚠ WARNING

Electric shock! Parts carrying dangerous voltages may be exposed when opening the cover and injury through electric shock.

► Before opening the cover, switch the device off and unplug the power cord.

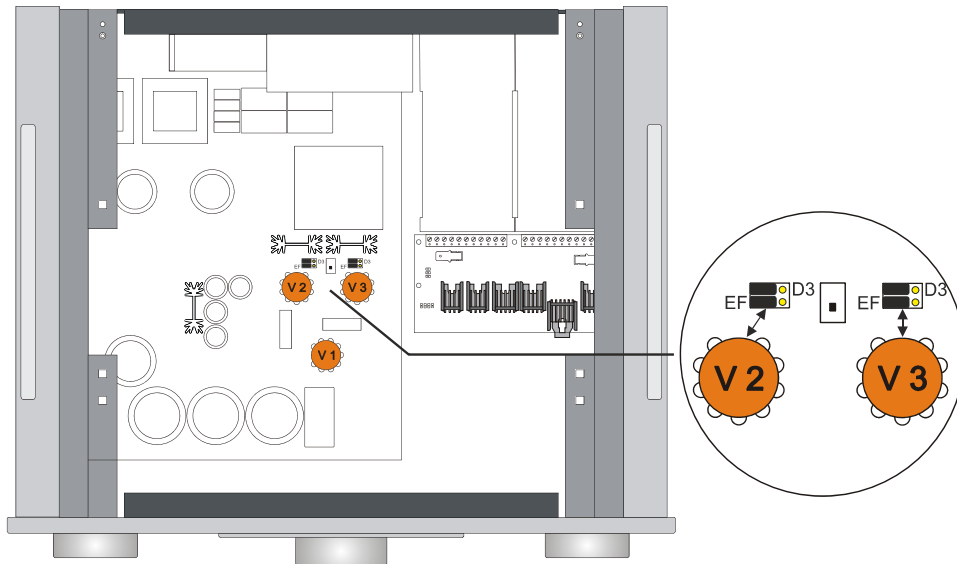

Tube layout: line board

Tube layout: line board

V 1 ECC82 (12 AU 7) (No option to adjust the tubes)

V 2, 3 2 x EF 800 (alternative 2 x EF 184) Jumper setting for position EF:

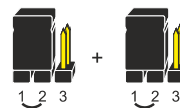

Pin1 and Pin2 are bridged

or

2 x D 3 A (alternative E 180 F)

Jumper setting for position D3:



Pin2 and Pin3 are bridged

Factory settings:

V1 12 AU 7 Tung Sol
 V2 + V3: 2 x EF 800 Telefunken (position EF)

TUBES Phono tube layout

9.2. Phono tube layout

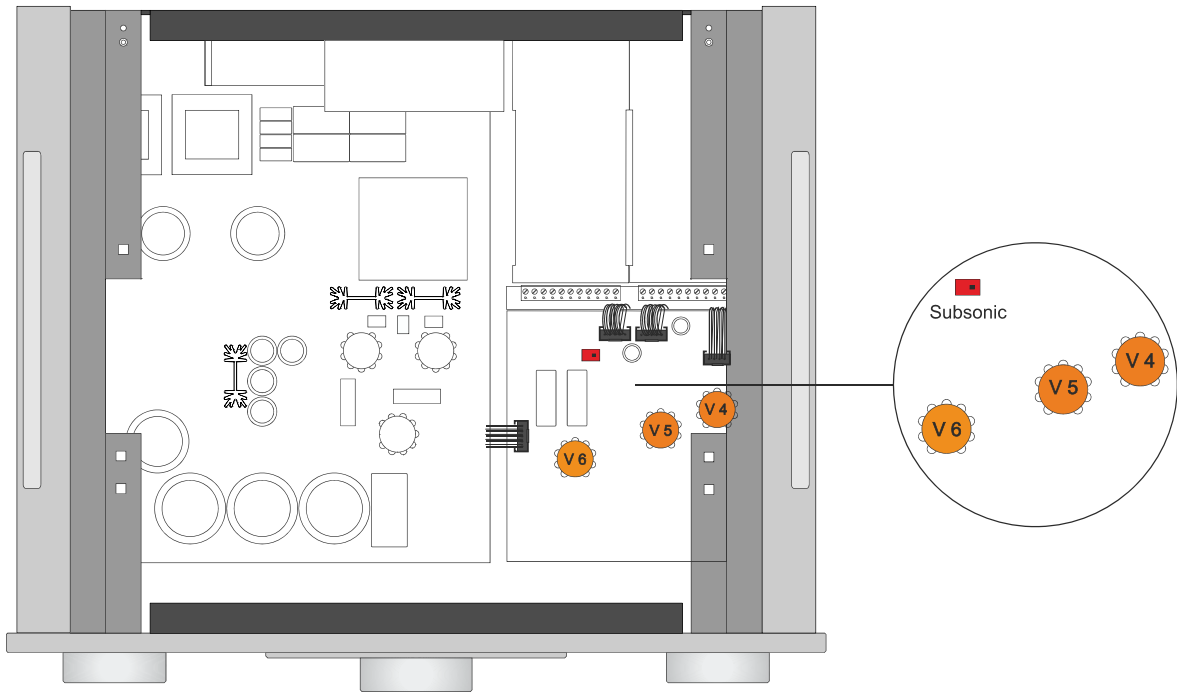

	German designation	International designation
V 4	ECC 83	12 AX 7
V 5	ECC 81	12 AT 7
V 6	ECC 88	6922, 6 DJ 8

TUBES

Control unit tube layout

9.3. Control unit tube layout

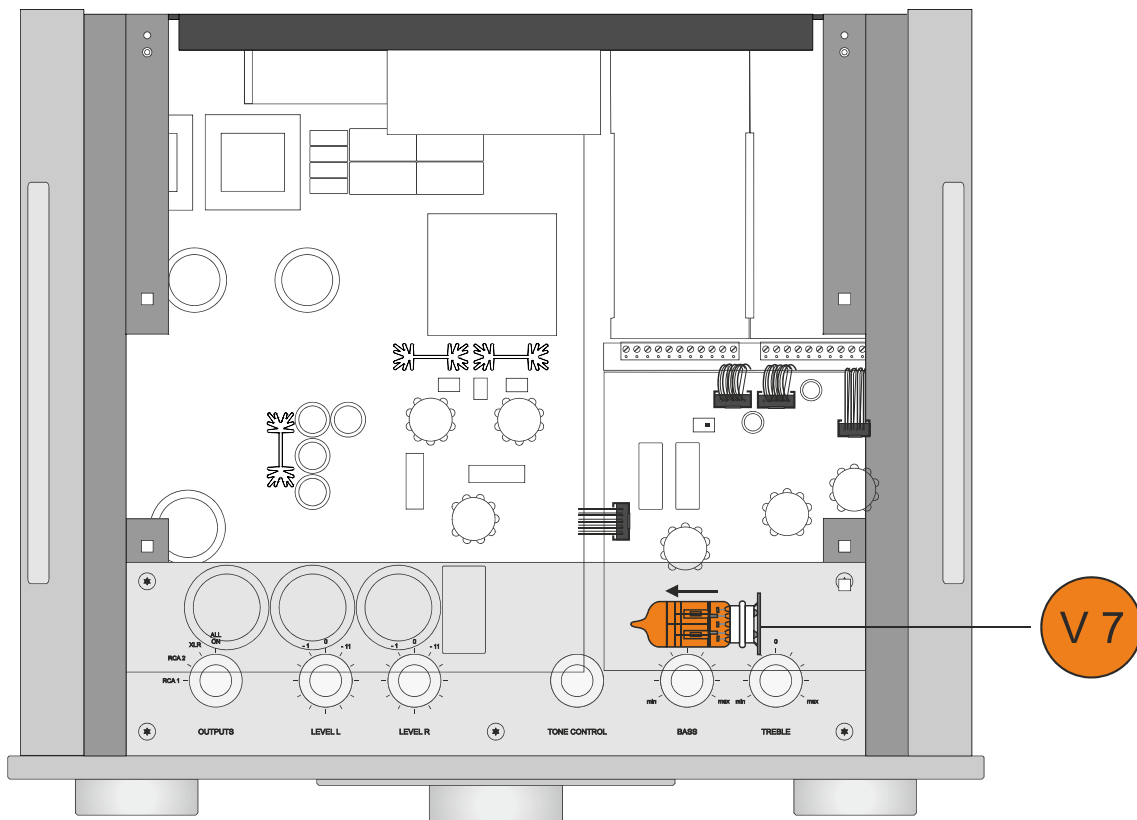

	German designation	International designation
V 7	ECC 88	6922, 6 DJ 8

Replacing the V 7 tube

Note The control unit cannot be disassembled during tube replacement, as it is physically connected to the front.

1. Disassemble the shortened cover.
2. If your device is equipped with the phono RIAA board, first remove the V 6 tube of the phono RIAA board.
3. Below the control unit, carefully remove the V 7 tube in the direction of the arrow.

TUBES

Replacing tubes

9.4. Replacing tubes

ATTENTION

Improper disassembly

Damage to the tubes due to improper disassembly or assembly.

- ▶ Changing tubes is a job for qualified technicians!

1. Switch off the preamplifier, unplug the power cord from the wall socket, and allow the unit 10 minutes to cool down.
2. Remove the cover by loosening the M4 torx screws (a total of 10 for the cover without control unit and 7 for the shortened cover with control unit). Do not remove the control unit from the device.
3. Carefully remove the tubes from their sockets, taking care not to exert sideward pressure on the sockets.
4. Fit new tubes. Please ensure that the tube pins are all perfectly straight before inserting your new tubes. Straighten any bent pins very carefully by hand if necessary.

Cleaning tips

Cleaning agents and contact cleaners are **not recommended** for tube sockets.

- ▶ Clean dirty sockets with compressed air and carefully clean tarnished tube pins using a wire brush or toothbrush.

Please note:

No adjustments are necessary to your amplifier after fitting new tubes.

It may take new tubes some time (up to 300 hours) to achieve their optimum sound quality.

Manufacturing faults in tubes may only become evident after about 100 hours of use. You should therefore be wary of installing untested tubes.

9.5. Tube service life

- Thanks to the protection circuits and soft start electronics, the output tubes used in your amplifier should achieve an **average service life of 5 to 10 years**.
- Because the tubes have different service lives, it should never be necessary to renew **the entire tube complement at the same time**.

OUTPUT RESISTANCE

Adjusting the output resistance

10. OUTPUT RESISTANCE

10.1. Adjusting the output resistance

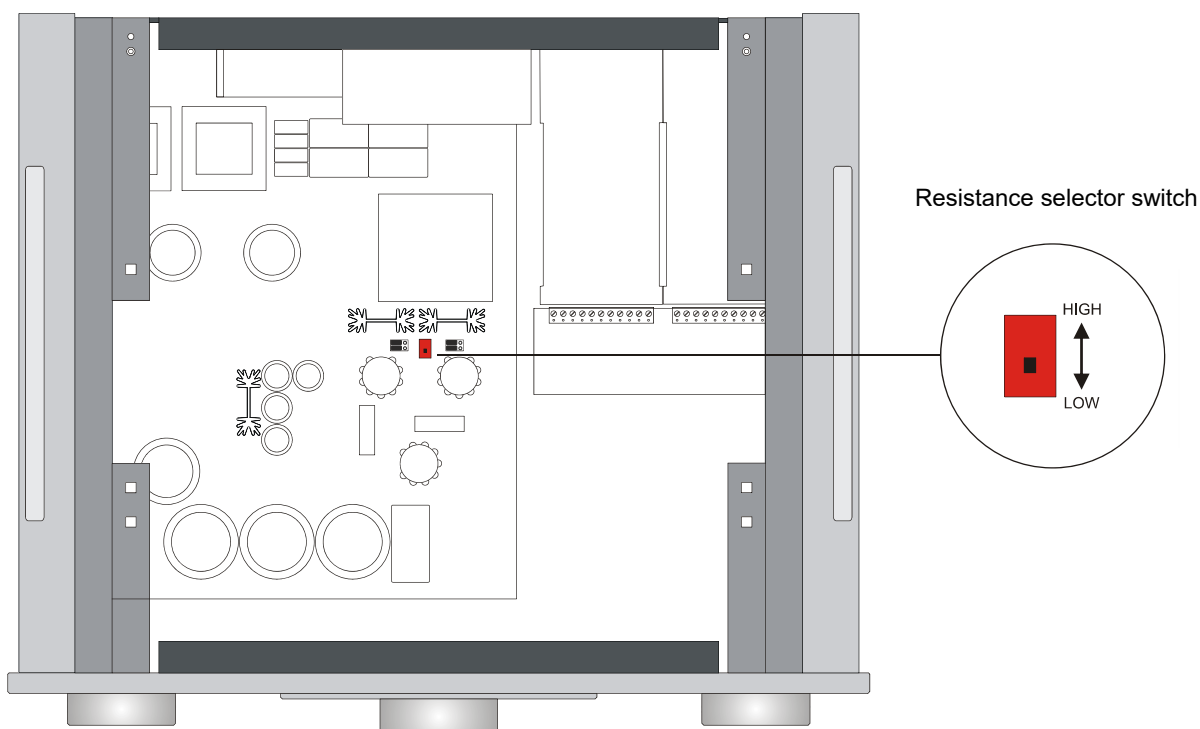

To change the output resistance of the line stage, set the resistance switch to LOW (100 ohm) or HIGH (300 ohm).

This allows you to adapt the preamplifier to the properties of the signal cable and the input resistance of the power amplifier. For power amplifiers with an input resistance under 10 kohm and cable lengths of 3 m and upward, select the setting LOW.

The output resistance influences the sound quality significantly. In the LOW setting, the sound production is very direct and contoured due to the line stage's higher capacity to supply power.

The setting primarily affects the RCA output; the XLR output is sufficiently low-resistance at 150 ohms.

The factory setting for the resistance switch is LOW.

OPTIONS

Option: Additional line-level input module

11. OPTIONS

11.1. Option: Additional line-level input module

The modular design of the **HP 700** offers the option to mount one or two additional line-level inputs beyond the existing line-level inputs (if the phono option is not installed, which requires at least one slot).

This can be advantageous if the existing number of inputs is insufficient or the transformer-coupled IN 8 is to be used for sound or technical reasons.

11.1.1. Assembling the additional line-level input module

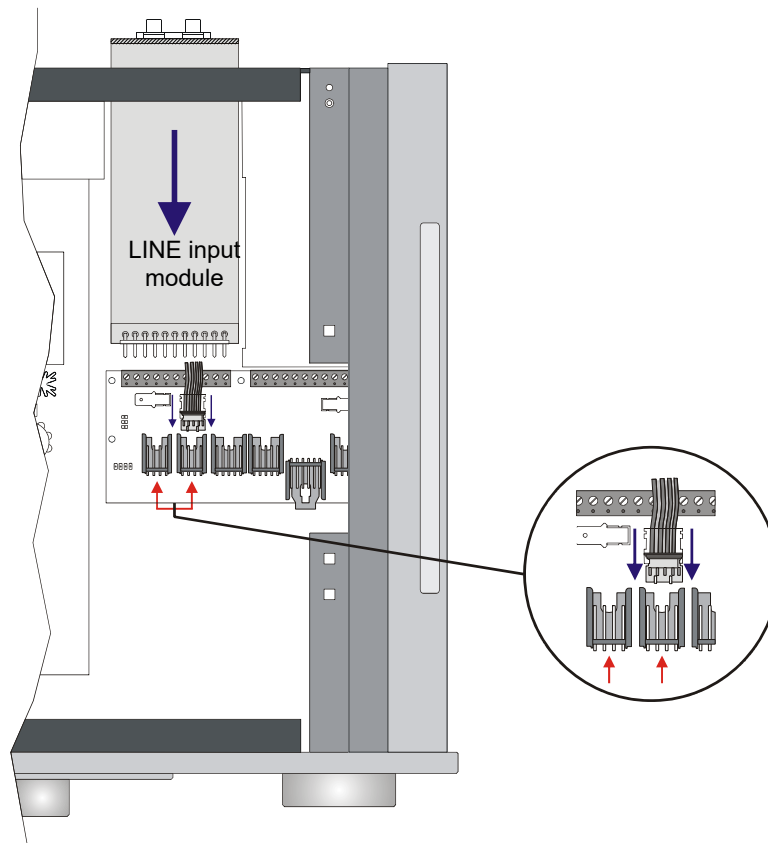

1. Remove the cover of the **HP 700** by loosening the screws using the supplied torx pin wrench and pulling off the cover upwards.
2. Remove the front panel on slot 1 or 2 on the front of the **HP 700** (4 M3 x 10 screws)
3. Make sure that the screws on the connector are all loose. Do not unscrew them completely.

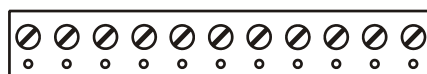

4. Guide the line-level input module through the opening at slot 1 or 2 so to insert the pins on the pin strip into the terminal screw strip.

OPTIONS
Option: Additional line-level input module

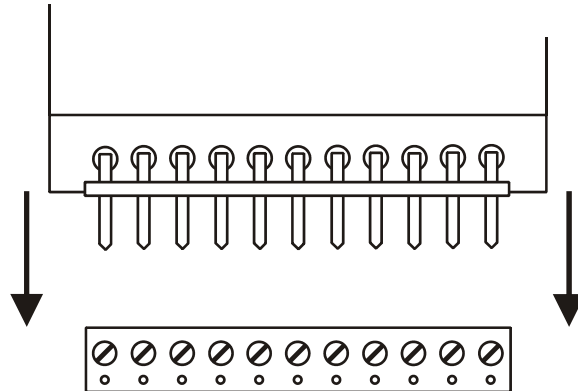

5. Secure the module **to the front side** of the **HP 700 first** using screws from the front panel.
6. Carefully screw in all the screws to the terminal screw strip. Do not tighten them too much.
7. Insert the flat connectors of the supplied ribbon cable in the designated slot on the adapter board on the **HP 700** (slots 1 and 2 are equivalent). The blade terminal cannot be twisted, since it can only be inserted in one position.
The input module ribbon cable plugs only fit in the two outer slots with 4 pins. (The other slots are reserved for connecting the phono board.)

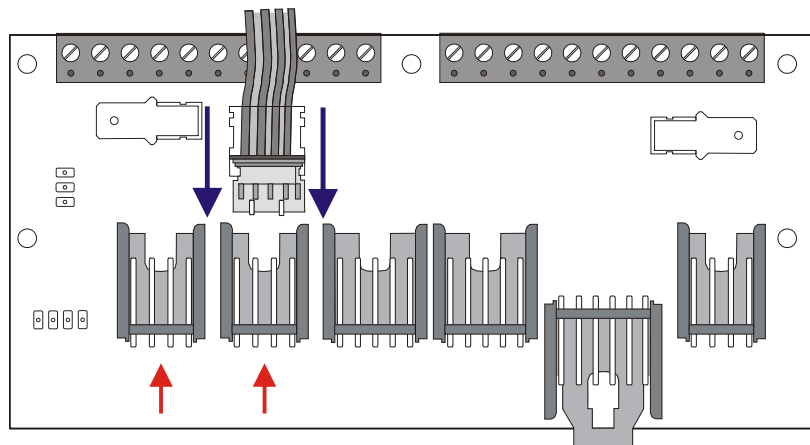

8. Close the cover on the **HP 700** and tighten the screws.

11.1.2. Available line-level input modules

See inlay manual “In- and Output Modules”

Effective 2017: IN4: RCA and XLR switchable
 IN8: XLR with transformer
 IN9: RCA with transformer

OPTIONS
Option HP 700 with phono

11.2. Option HP 700 with phono

11.2.1. HP 700 with phono RIAA

A record player is an electro-mechanical device. Music signals are “pressed” into the grooves in the record, and these are physically tracked and read by the pickup cartridge. In order to get the entire 20 Hz - 20 KHz frequency range into the grooves, the frequency response has to be shaped by lowering the level of the low-frequency information and raising the level of the high-frequency information. This predefined equalization curve is known as RIAA equalization.

A phono amplifier must be able to reproduce the RIAA equalization to avoid coloring the sound. Equalization accuracy must be within 0.5 dB over the entire frequency range, with channel matching of at least 0.1 dB.

The phono RIAA amplifier of the HP 700 must always be supplemented with an input module. A maximum of two phono input modules can be installed. The input modules function in the same way as an input amplifier that raises the different signals of the pickup cartridge to a constant, high level, which the RIAA amplifier can optimally process.

Phono is then selected via IN 1 to IN 2.

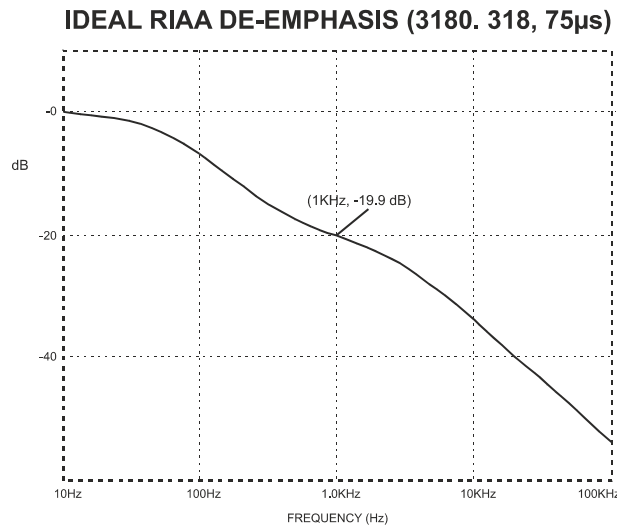

Possible input module variants with the phono option:

Phono RIAA must be installed	Slot 1	Slot 2
At least 1 phono input module	Phono input	Nothing
At least 1 phono input module	Nothing	Phono input
2 identical or 2 different phono inputs	Phono input	Phono input
1 phono input and 1 line input	Phono input	Line input
1 phono input and 1 line input*	Line input	Phono input

*This variant is not recommended because the line signal routing is crossed

OPTIONS

Option HP 700 with phono

11.2.2. Subsonic filter

Warped records and unfavorable pickup cartridge/pickup arm combinations can cause major low-frequency interference that impairs bass reproduction. These low-frequency levels can be attenuated with the switchable subsonic filter. The corner frequency is outside of the audible range at 15 Hz. Condition on delivery: Subsonic filter on.

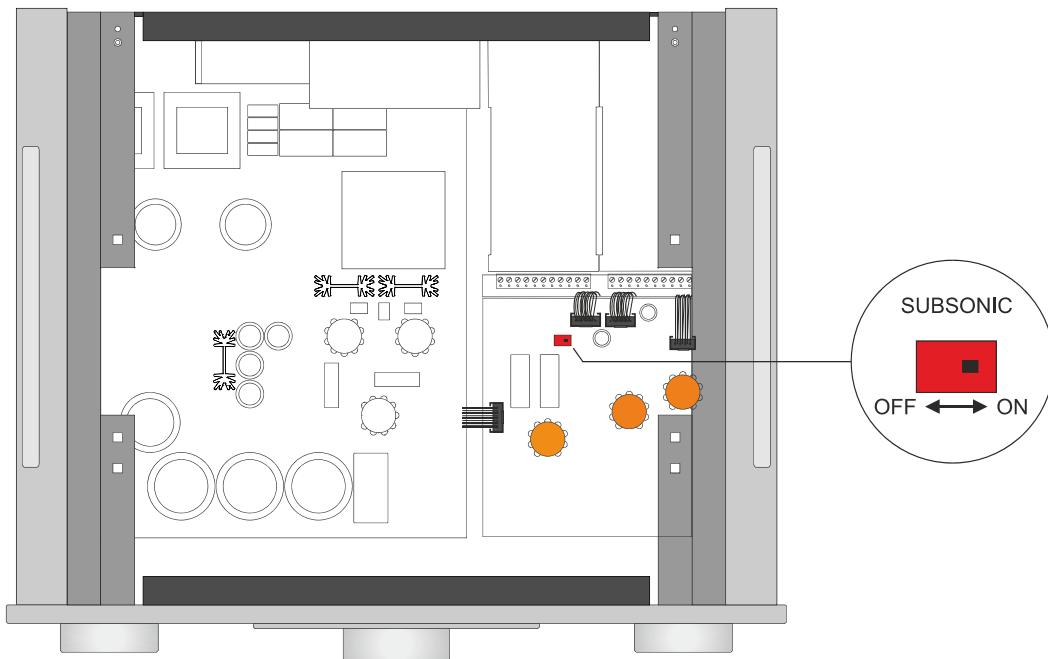

Phono frequency response with and without subsonic filter

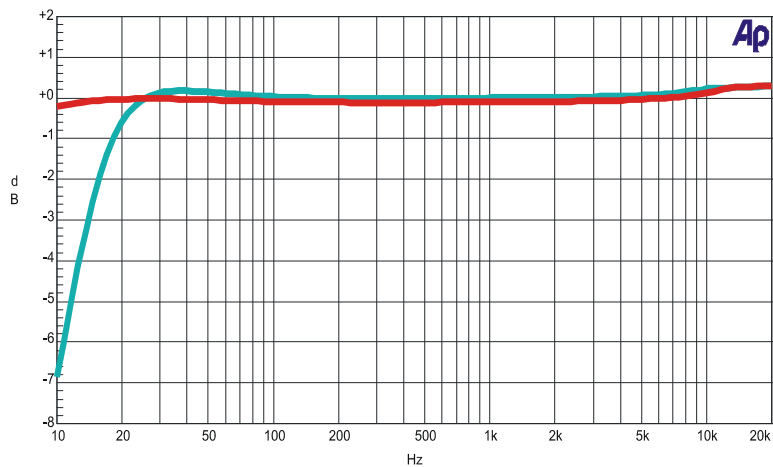

The frequency range without subsonic filter is very linear and extremely low (red graph). With the subsonic filter (cyan graph), bass reproduction is not limited by the low corner frequency (-3 dB at 15 Hz).

OPTIONS

Option HP 700 with phono

11.2.3. Assembling the phono input modules

The phono input modules are assembled in the same way as the line input modules, though their assembly is simpler due to an absence of cables to be connected.

Note If your system is not equipped with a phono main circuit board (phono RIAA), you can theoretically also insert the phono inputs, but no sound can be produced!

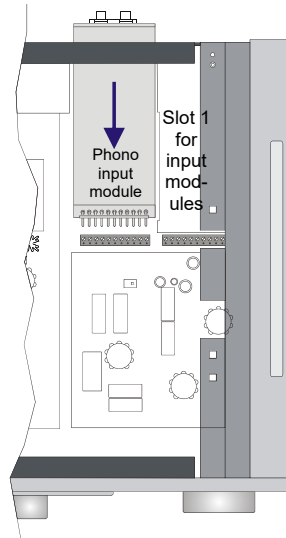

Module assembly

⚠ WARNING

Electric shock

Parts carrying dangerous voltages may be exposed when opening the cover and cause death or injury through electric shock.

► Before opening the cover, switch the device off and unplug the power cord.



1. Loosen the M4 torx screws on the cover and pull off the cover plate upwards.
2. Loosen the 4 Phillips-head screws on the corresponding rear cover panel and remove the cover panel.
3. Loosen the screws on the corresponding terminal screw strip.
4. Insert the module into the slot so to insert the module pins into the screw-connector on the main circuit board.
5. Then, screw the rear panel back on.
6. Re-tighten the screws on the terminal screw strip. Do not tighten them too much!
7. Screw the cover back on.

11.2.4. Available phono input modules

See inlay manual "In- and Output Modules"

Effective 2017: IN1: MM RCA // IN2: MC RCA // IN3: MC XLR // IN6: MC RCA Step-Up-Transformer switchable // IN7: MC XLR Step-Up-Transformer switchable

OPTIONS
Option: HP 700 with control unit

11.3. Option: HP 700 with control unit

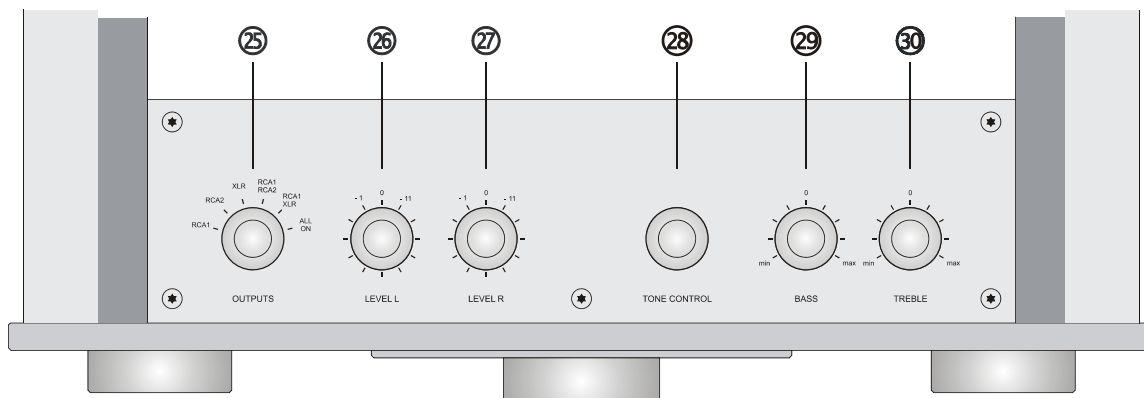

Legend

(25)	Output selector switch	Here, the three outputs RCA 1, RCA 2, and XLR can be activated separately and in groups. In the ALL ON setting, all three inputs are active and can be used simultaneously. The settings RCA 1 and RCA 2, or RCA 1 and XLR are intended for bi-amping configurations, each with a separate power amplifier (e.g. a headphone amplifier). The separate power amplifier can then be operated on XLR or RCA 2.
(26) + (27)	Pre-level control – left and right channel	The Level L and R controls are used to precisely reduce the channels in 1 dB increments separately for each channel. This allows for the accurate adjustment of the reproduction balance. The controls are step switches, ensuring exact accuracy and absolute long-term stability. The controls are bypassed in the 0 dB setting. Control is frequency-compensated and thus does not negatively affect the quality of the music signal. Frequency-compensated attenuators originate from high-frequency technology. Compared to more simple, non-compensated variants, their advantage is that the frequency bandwidth and phase shift are not affected.
(28)	Rotary knob for activating the tone control	When the tone control is on, the TC LED on the front illuminates. When the tone control is off, the electronic control system is bypassed completely.
(29) + (30)	Bass and treble controls	These controls allow for precise raising and lowering of the bass and treble. One scale mark corresponds to +/- 3 dB.

The control unit is a special feature of the **HP 700**. The combination of **level adjustment** and the **tone control** allows for a more precise correction of reproduction under unfavorable conditions, be it due to the room acoustics or the sound carrier.

The **level adjustment** (individual volume control per channel) is virtually indispensable if the loudspeakers are placed at different distances to the listener (e.g. due to spatial reasons). The level control can be used to adjust the channels to the listener **without losing audio quality** (see (26) + (27)).

The **tone control** is achieved through tube technology and ensures a homogeneous sound pattern.

OPTIONS

Option: HP 700 with control unit

The components used, low-noise conductive plastic controls with minimal channel tolerance, and low-tolerance polypropylene capacitors, in conjunction with the latest optimized tube stage advance the sound properties of the classic tone control to an unprecedented level. Precise adjustment allows for tonal corrections in the bass or treble ranges. Corrections are equally helpful in old muffled and bass-weak analog recordings and in new digital productions, which sometimes feature a distinct high frequency tending towards sharpness. Here, corrections of 3 dB truly work wonders.

Technical data

Frequency response 0 dB	10 Hz – 140 kHz
Total harmonic distortion + noise	< 0.1 %
Noise voltage	5 μ V
Setting range	+/- 15 dB

Control characteristics of the tone control

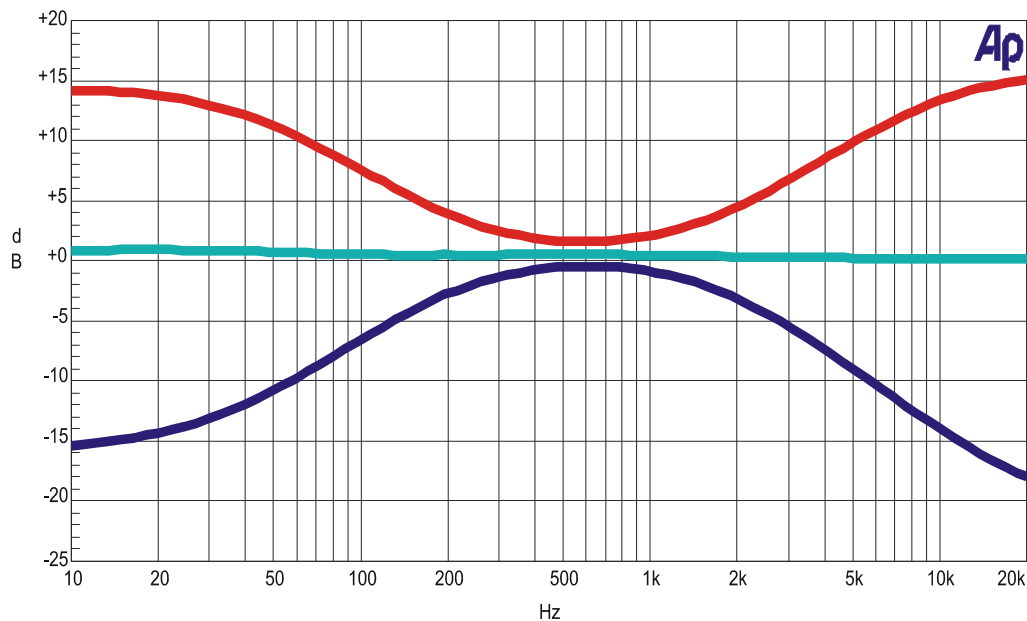

The control range encompasses the area between the red and blue graphs. The precisely adjustable controls allow for settings in the 1 dB range based on the scale. One scale mark corresponds to +/- 4 dB.

OPTIONS

Option: HP 700 with stepped attenuator

11.4. Option: HP 700 with stepped attenuator

The volume control is an important component of a preamplifier. The demands placed on the controls are very high. The control range must encompass at least the range of 1:3000 (or 1:0.00033) to ensure fine adjustment appropriate for human hearing.

At the same time, the channel deviation within this range must not exceed 1 dB. The transfer resistance should remain constant during and after adjustment to prevent control noises. Rotary controls with a resistance track sensed by a slide meet these requirements to a large extent with our strict selection, but spring-guided sensing of the resistance track can result in undesired resonance effects that negatively affect the transfer resistance and impair the signal in the micro range. As a result of this design, the frequency bandwidth, i.e. the speed, may also be limited, depending on the control setting.

The control concept can only be improved with a stepped attenuator. In this complex process, the resistance track is reproduced by a series circuit consisting of individual resistors. The stepped attenuator now senses the connecting points of the resistor ladder. The advantages of this solution are obvious: thanks to the low-tolerance fixed resistors, the channel tolerance across the entire control range remains under 0.1 dB. The hard gold plated contacts on the switch have an extremely low transfer resistance and thus do not generate micro-fluctuations in the signal level caused by mechanical resonances.

The switch has 47 settings. This uncommonly high number of settings allows for finely incremented, reproducible volume adjustment.

To eliminate the effect of the control, or the control setting, on the bandwidth, the stepped attenuator – as in the balance controls – is frequency-compensated. Equipped with this unique switching layout, the OCTAVE stepped attenuator functions as an ideal control. The sound characteristics are constant across the entire control range, while the center position also remains stable across the entire range thanks to the negligible channel tolerance. The sound pattern gains depth and the finest subtleties are audible in the layers of sound.

However, as a result of the mechanical design of the stepped attenuator, the switch positions cannot be controlled using the remote control

TROUBLESHOOTING

Troubleshooting

12. TROUBLESHOOTING

12.1. Troubleshooting

Hum and crackling

Hum in an audio system is often caused by several system components being grounded individually. It is particularly common with tuners, VCRs, or satellite receivers, where the grounded aerial cables cause a ground loop via the aerial input. Power amplifiers are normally also grounded. Removing the ground wire on your safety plugs is not a solution. You can isolate the aerial earth connection with a special signal isolator. This device has no adverse effect on the sound or picture quality of tuners or TVs.

The HP 700 is not grounded and therefore cannot cause ground loops.

Solution The XLR output on the **HP 700** can be connected without ground connection to interrupt a ground loop in the power amplifier with a grounded source device. Alternatively, the IN 8 line input module can be used. This transformer-coupled XLR input module also allows for ground separation.

Clicks and pops

Older refrigerators and 12 V halogen lamps can generate strong radio interference, and when they are switched on and off, audible clicks and pops in the system's loudspeakers may occur.

Solution The only solution is to use a single-power socket board for your entire system and to use a different power outlet in your listening room.

Channels are not balanced

Check that the RCA plugs are plugged in properly. Bend the outer ground contacts inward if necessary. Sometimes the internal pin in an RCA plug may not be a tight enough fit, in which case you should either replace the cable or the socket.

1) Damaged cables and poorly fitting RCA plugs can create resistance in the signal path, enough to reduce the output level of one channel.

Solution Try new cables or clean plugs and sockets with isopropyl alcohol. You could also try cleaning or contact fluid.

2) A faulty tube can cause a drop in output in one channel and generate distortion. This is a rare occurrence, the heater inside the particular tube may also be the cause of the problem.

Solution Replace the tube.

Increased hiss on one channel

Hiss that varies in level is a sign of a faulty or worn driver tube.

Solution Replace the worn tube.

Tubes with this type of error can generally still be used in power amplifiers; the increased hiss is rarely an interference.

TECHNICAL DATA
In- and outputs

13. TECHNICAL DATA

13.1. In- and outputs

In- and outputs	
Inputs	3 x RCA, 2 x XLR, 2 x arbitrary 1 x RCA bypass (can be switched to IN4-XLR)
Outputs	2 x RCA, 1 x XLR, 1 x Monitor/Tape Record (RCA)
XLR transmission ratio	0 dB
XLR pin assignment	1 = ground, 2 = positive, 3 = negative

Line stage	
Output resistance	100/300 ohms RCA; 150 ohm XLR
Monitor Out output resistance	240 ohms
Maximum output voltage	12 V
Gain factor – Gain High	25 dB = 18.5
Gain factor – Gain Med	18 dB = 7.8
Gain factor – Gain Low	12 dB = 4
Signal-to-noise ratio – Gain High	-98 dB/38 μ V at 3 V output voltage
Signal-to-noise ratio – Gain Med	-104 dB/18 μ V at 3 V output voltage
Signal-to-noise ratio – Gain Low	-110 dB/8 μ V at 3 V output voltage
Equivalent noise level	14 nV \square Hz
Frequency range – Gain High, RCA	10 Hz – 200 kHz -0.7 dB / 0.7 MHz -6 dB
Frequency range – Gain Med, RCA	10 Hz – 200 kHz -0.3 dB / 1.3 MHz -6 dB
Frequency range – Gain Low, RCA	10 Hz – 200 kHz -0.2 dB / 2.1 MHz -6 dB
Frequency range – XLR	10 Hz – 200 kHz -1.5 dB
Ramp-up time – Gain Low	250 ns
Ramp-up speed – Gain Low	60 V/ μ s
Total harmonic distortion – Gain Low, Med, High	0.01 % at 3 V on 10 kohm
Channel separation	-90 dB/1 kHz, input short-circuited
Crosstalk between inputs	-80 dB/RCA, -95 dB XLR/1 kHz
Input resistance	50 kohm
Channel matching via volume control	0.5 dB – 70 dB

TECHNICAL DATA
In- and outputs

Phono	
RIAA equalization tolerance	0.3 dB/15 Hz – 20 kHz
Corner frequency – subsonic filter	15 Hz/-3 dB
Signal-to-noise ratio	-75/-84 dB/with IN 2 MC input
Input sensitivity	250 μ V/600 μ V/with IN 2 MC input
Input sensitivity, gain and input resistance depend on input module	
Gain – MC Gain Low - Pre Out	Gain Low: 70 dB, Med: 77 dB, High: 83 dB
Gain – MC Gain High - Pre Out	Gain Low: 79 dB, Med: 86 dB, High: 92 dB
General data	
Power consumption	35 – 60 W
Weight, preamplifier/power supply	10 kg/3.8 kg
Supplied accessories	Power cable, remote control
Dimensions of preamplifier (overall)	Width x height x depth = 462 x 130 x 480 mm
Dimensions of power supply (overall)	Width x height x depth = 110 x 90 x 277 mm

TECHNICAL DATA
Dimensions

13.2. Dimensions

13.2.1. HP 700 preamplifier (dimensions in mm)

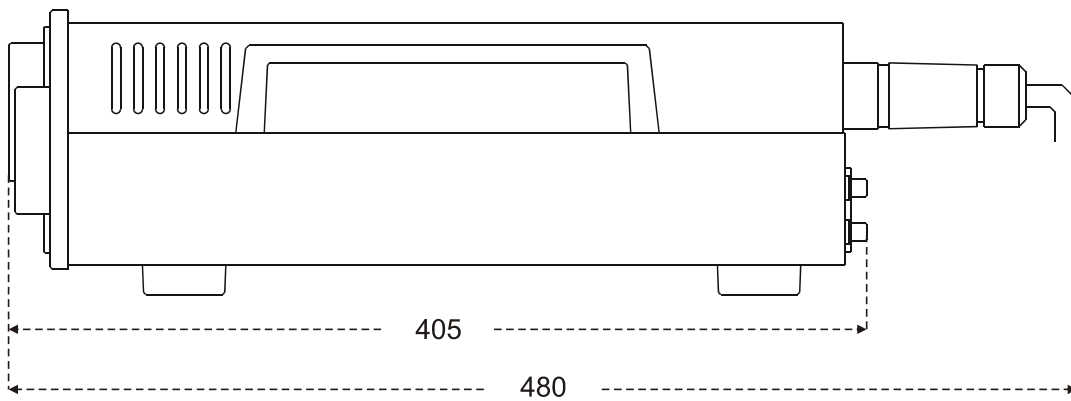
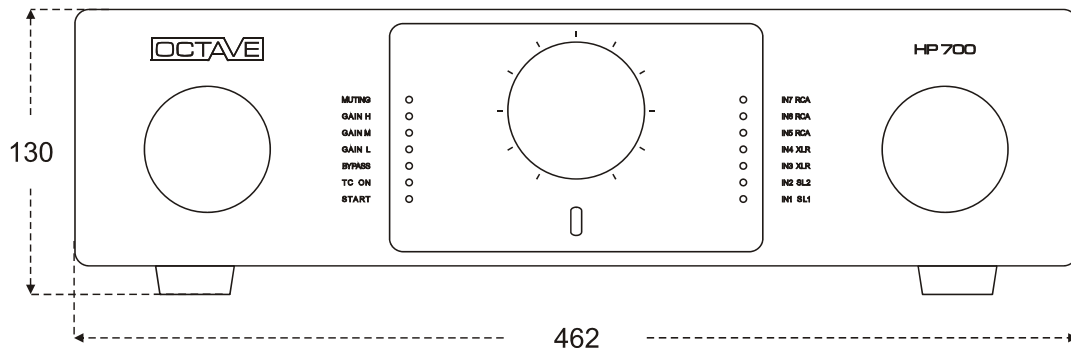

13.2.2. External power supply (dimensions in mm)

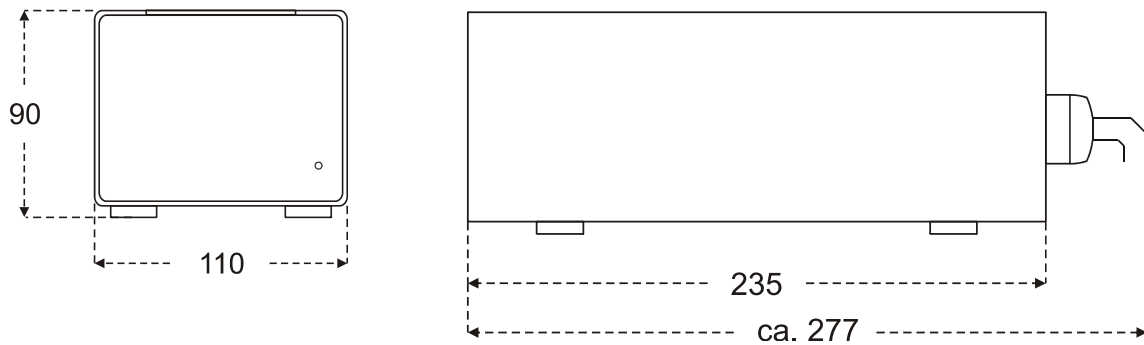

TECHNICAL DATA
Diagrams

13.3. Diagrams

13.3.1. HP 700 line frequency response

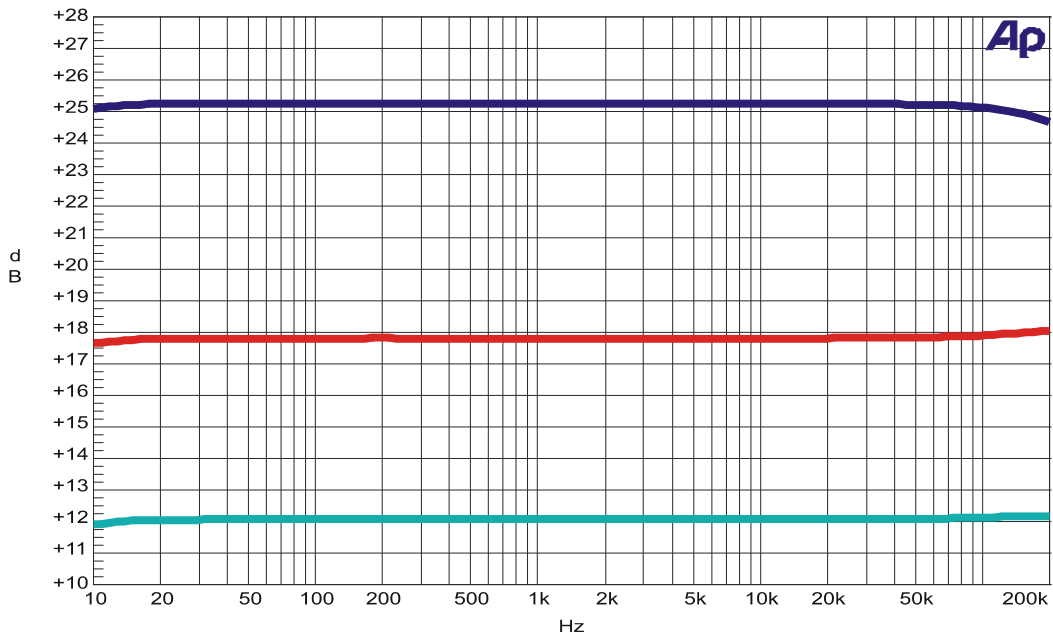

Frequency response and gain of line stages in Gain Low (12 dB), Med (18 dB), and High (25.5 dB) settings.

13.3.2. FFT interference spectrum

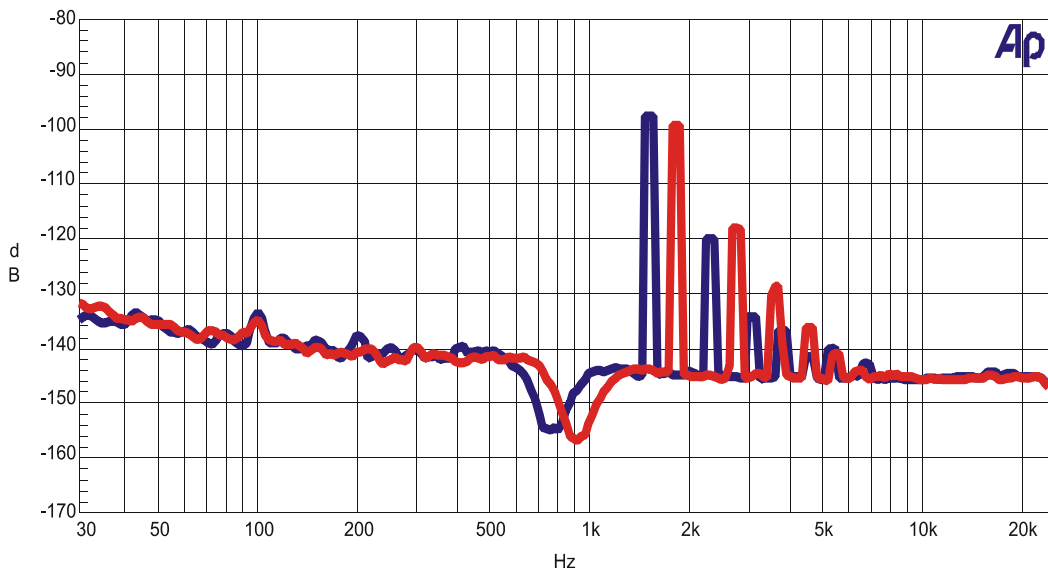

Comparison of the RCA and XLR interference spectrum. No mains interference on either of the inputs; the spectrum of the harmonics K2, K3, K4, K5, K6 decreases consistently linearly for both outputs.

TECHNICAL DATA
Diagrams

13.3.3. Control range and balance control frequency response

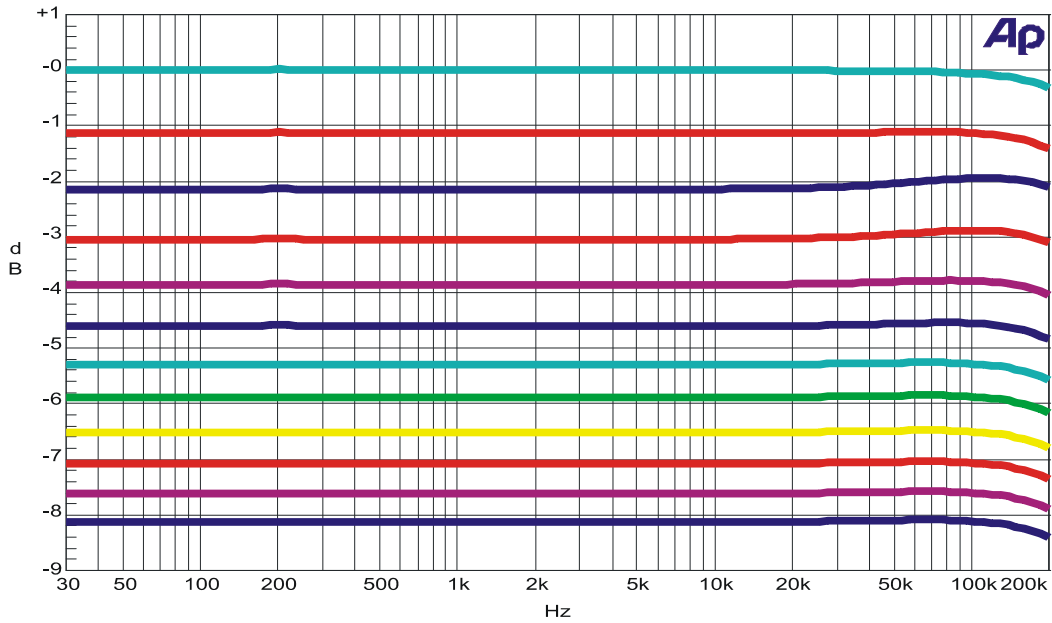

The compensated balance pre-control exhibits virtually the same frequency response with all settings.

13.3.4. Line stage hum and noise level

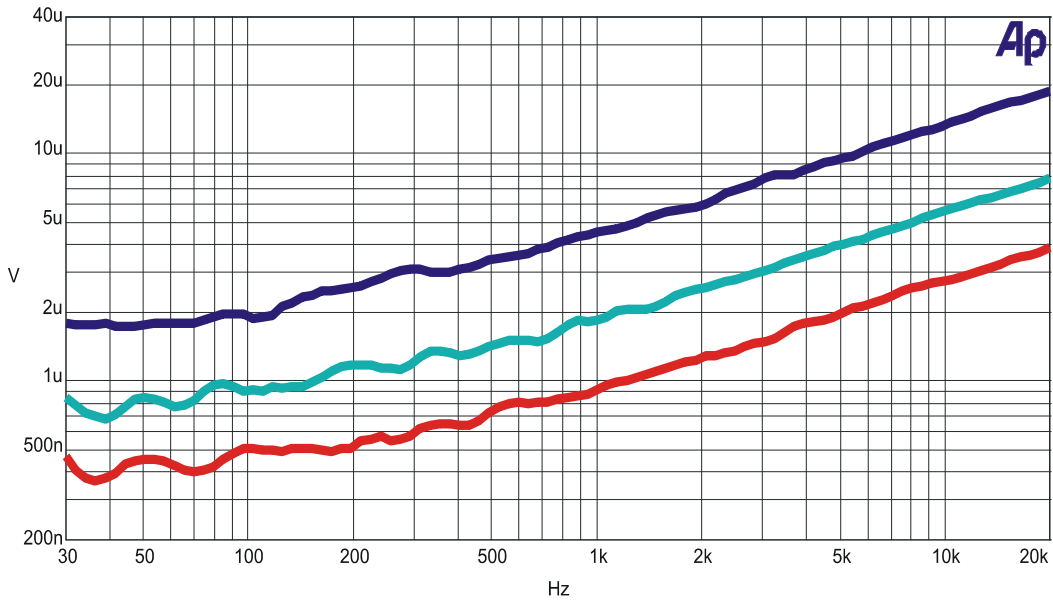

No mains interference can be detected during noise level measurement either; the noise level decreases linearly by 6 dB for each gain setting.



We reserve the right to alter and improve the specifications in pursuit of better. OCTAVE is a registered trademark of Andreas Hofmann. This manual is the copyright of Andreas Hofmann, OCTAVE.

Reproduction in whole or part is prohibited. EN2017

OCTAVE AUDIO
Germany
www.octave.de